

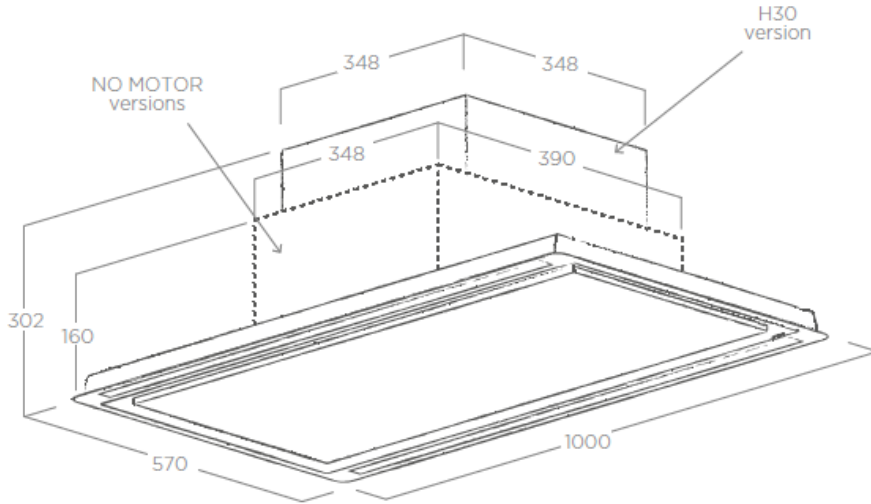

# SERVICE MANUAL HILIGHT GLASS H30

SM2300014

## Product presentation / presentazione prodotto



IN CASE OF DISINSTALLATION AND INSTALLATION OF THIS PRODUCT / IN CASO DI DISINSTALLAZIONE E INSTALLAZIONE DI QUESTO PRODOTTO



Product presentation / presentazione prodotto

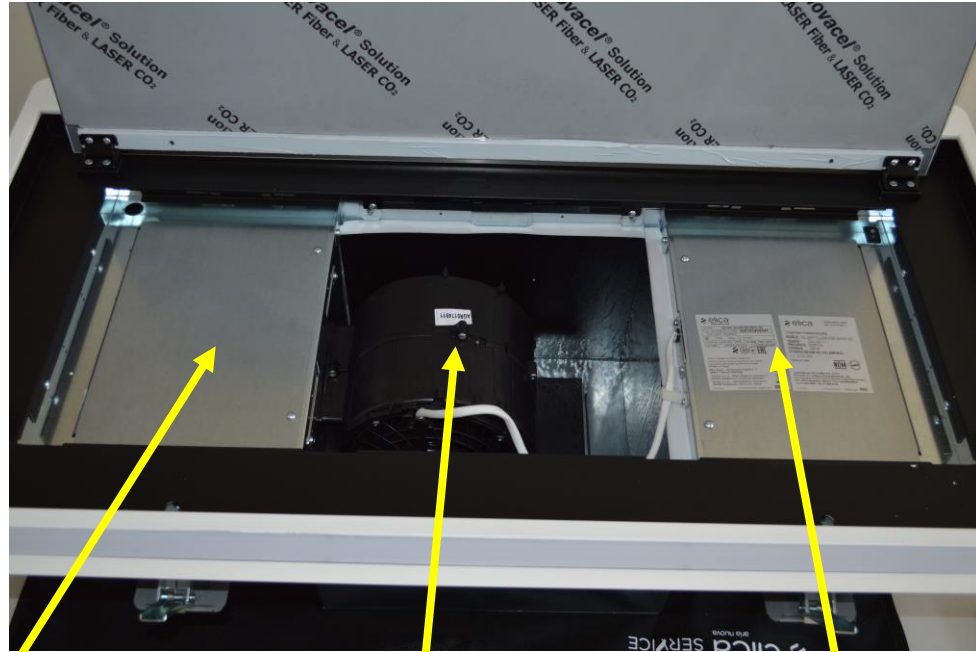

Illumination device  
/ Impianto luce

Blower/ Aspiratore

Electronic device  
/ Impianto elettrico

## HOW TO REMOVE ILLUMINATION PANEL / COME RIMUOVERE L'ILLUMINAZIONE



Lift up the LED bar using a screwdriver. ATTENTION: BE CAREFULLY TO NOT DAMAGE THE FRAME. Disconnect the LED bar connection in order to replace it / Sollevare la barra LED con un cacciavite. ATTENZIONE:NON DANNEGGIARE IL TELAIO. Disconnettere il cablaggio della lampada LED

## HOW TO REMOVE ILLUMINATION PANEL / COME RIMUOVERE L'ILLUMINAZIONE

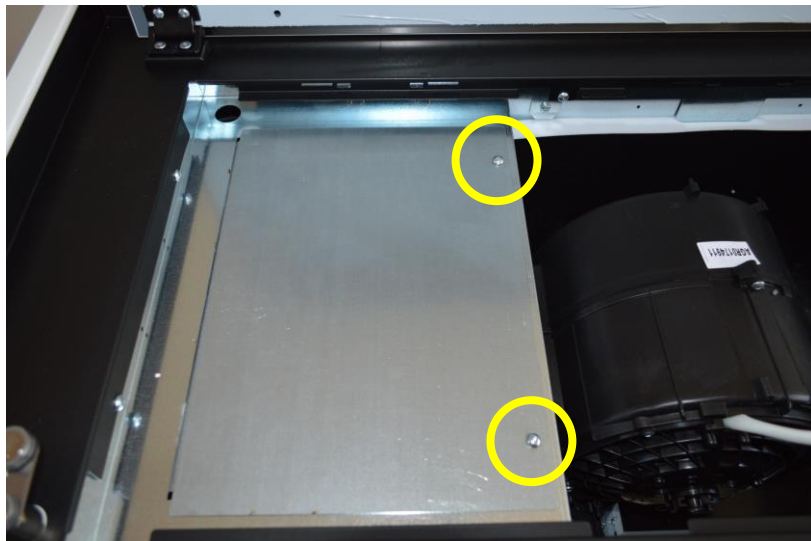

Remove 2 screws to get access to transformers /  
rimuovere le 2 viti per accedere ai trasformatori

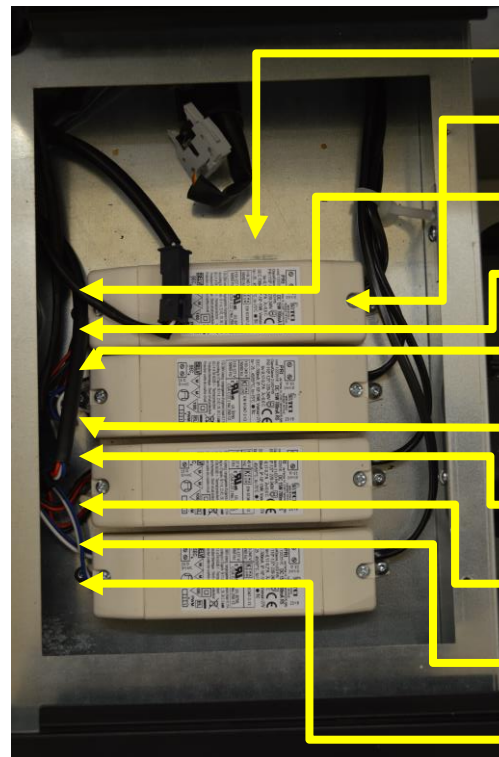

Transformer LED barre

230V Power in-put

12V Power out-put  
LED barre1 warm light

Signal in-put warm light

12V Power out-put  
LED barre1 cold light

Signal in-put cold light

12V Power out-put  
LED barre2 warm light

Signal in-put warm light

12V Power out-put  
LED barre2 cold light

Signal in-put cold light



## HOW TO REMOVE ELECTRONIC DEVICE/ COME RIMUOVERE L'ELETTRONICA

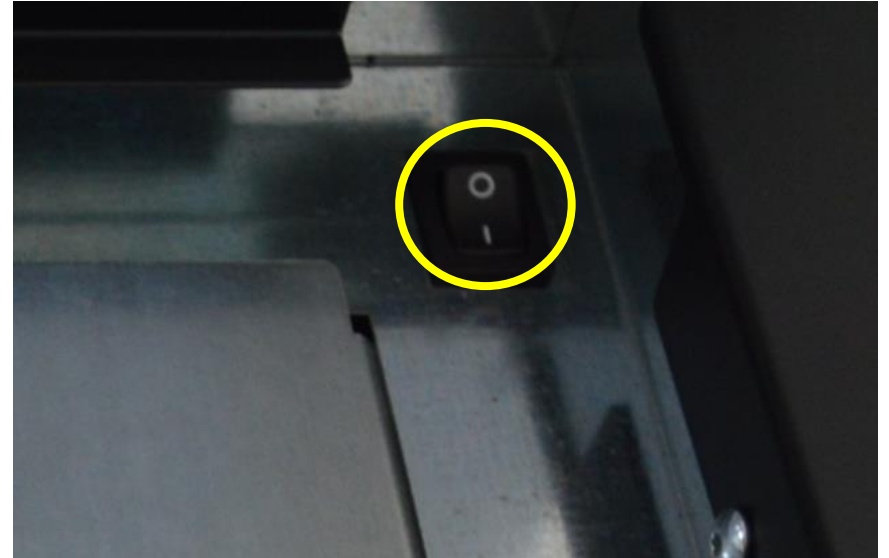

Unscrew 2 fixing screws of electronic device cover to get access to LED connection. In this model there is an ON-OFF switch / Svitare n. 2 viti di fissaggio del coperchio del dispositivo elettronico per accedere alla connessione LED. In questo modello è presente un interruttore on-off

## HOW TO REMOVE ELECTRONIC DEVICE/ COME RIMUOVERE L'ELETTRONICA

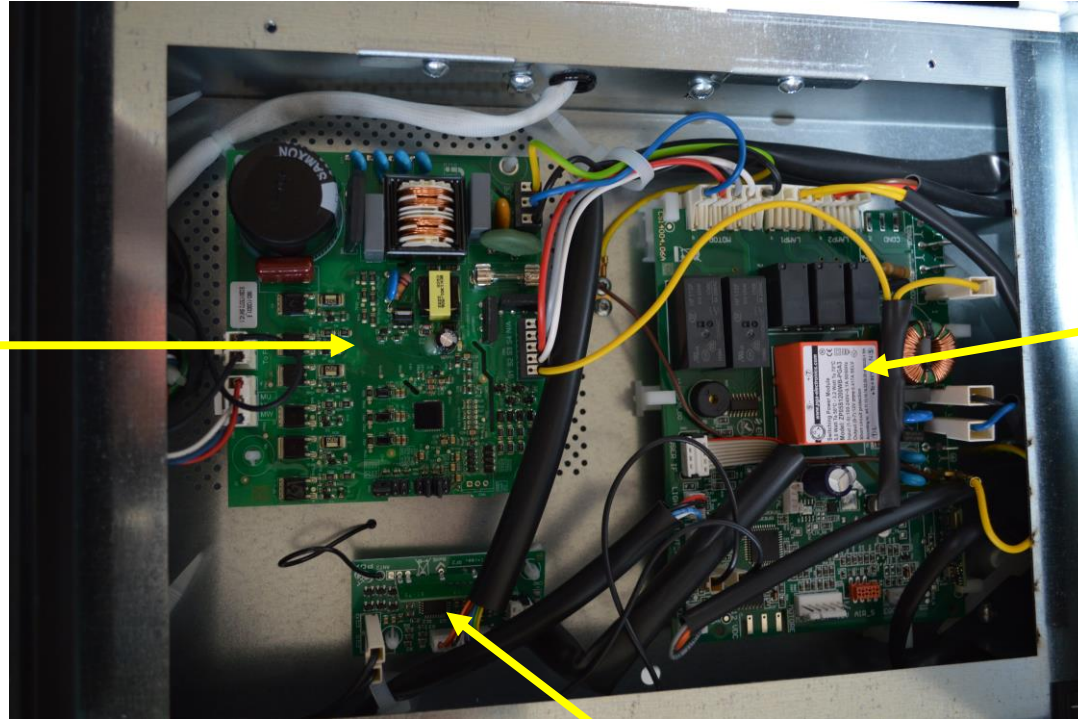

BLDC Motor board  
/ BLDC scheda  
motore

Main board  
/ scheda principale

UI-RX board / UI-RX scheda

# SERVICE MANUAL HILIGHT GLASS H30

## HOW TO REMOVE ELECTRONIC DEVICE/ COME RIMUOVERE L'ELETTRONICA

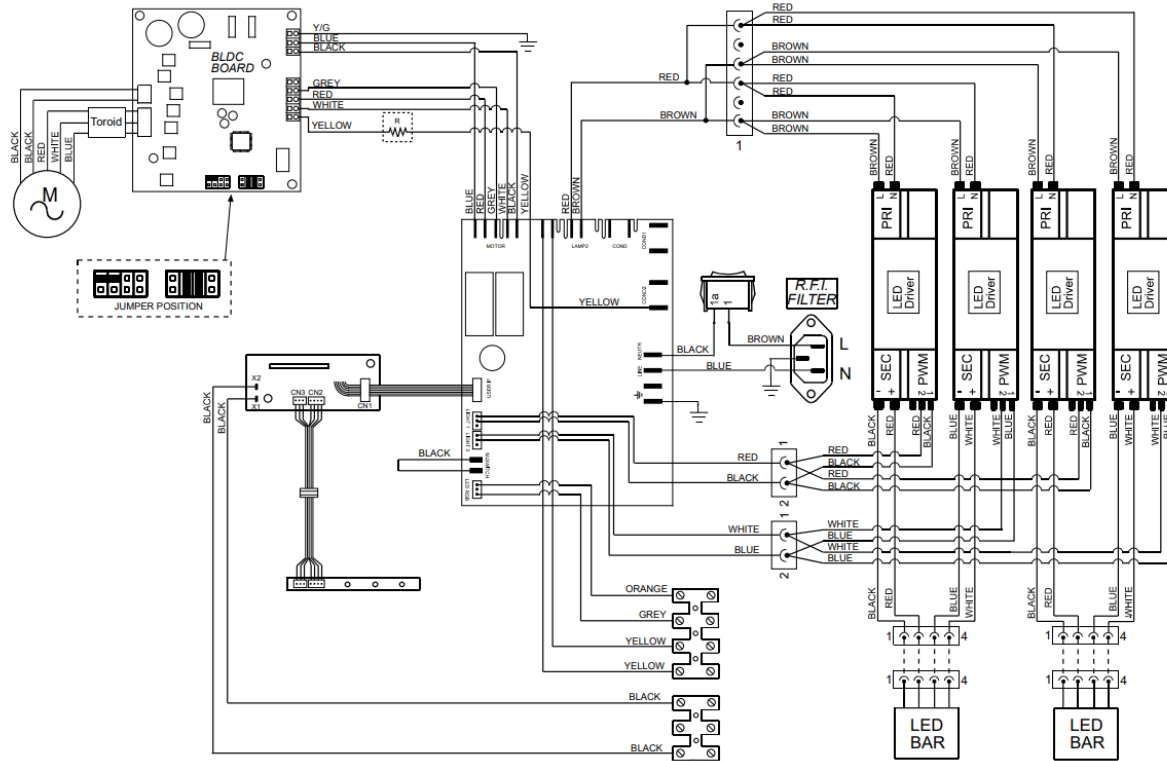



IF MOTOR DOES NOT RUN CHECK FOLLOWING / SE IL MOTORE NON PARTE DA CONTROLLARE



1. Check if control LED is white
2. Bring antenna out of the E-Box, if no improvement cut antenna
3. Connect remote control to charger during testing
4. Run sync again with the product

1. Controlla che luce è bianca
2. Portare l'antenna fuori dall'impianto elettrico, se non migliora taglia l'antenna
3. Collega il telecomando al caricatore
4. Effettuare affiliazione

IF MOTOR DOES NOT RUN CHECK FOLLOWING / SE IL MOTORE NON PARTE DA CONTROLLARE

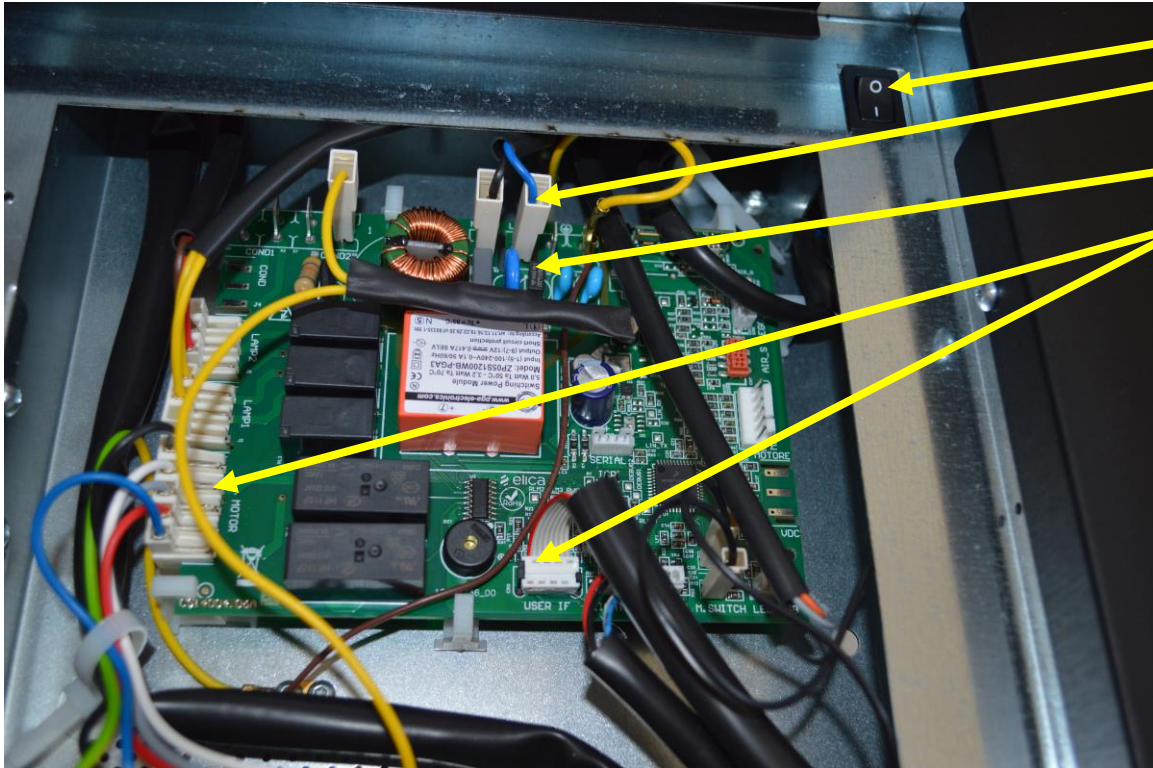

1. Check if main switch is on
2. Check if power supply reach the main board
3. Check if fuse is broken
4. Check if 230V is at out-let wire black/blue when speed is on
5. check that all connections are fit proper

1. Controlla che l'interruttore è a 1
2. Arriva la corrente alla scheda principale
3. Fusibile è aperto
4. Esce 230V ai fili nero/blu se il motore è acceso
5. Controlla che tutte le connessione sono ok

IF MOTOR DOES NOT RUN CHECK FOLLOWING / SE IL MOTORE NON PARTE DA CONTROLLARE

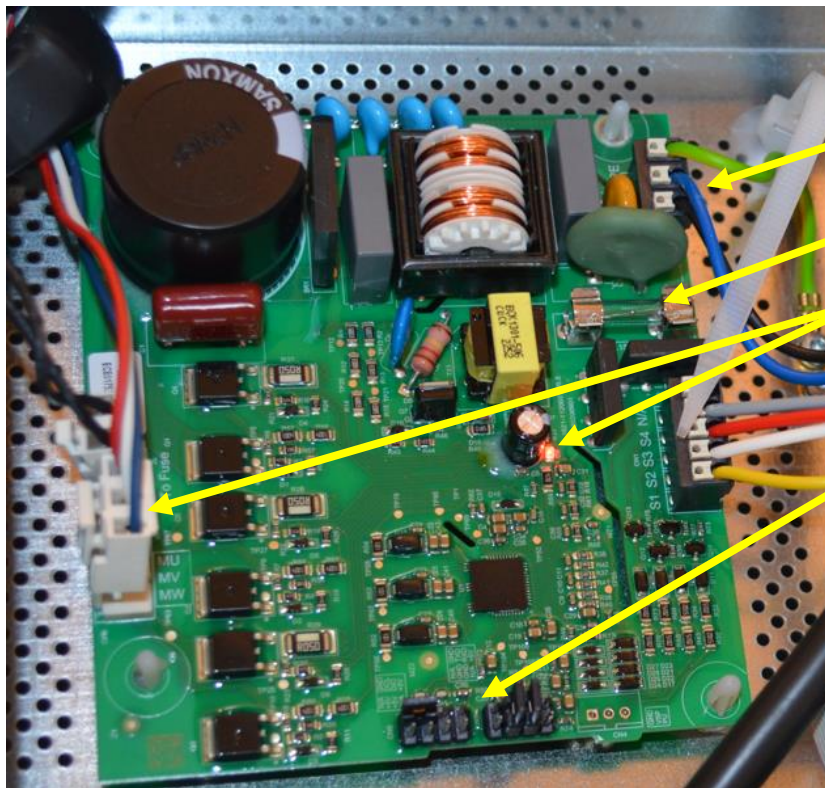

1. Check if power supply reach the main board
2. Check if fuse is broken
3. Check if diode is on
4. Check if motor connectors are placed correctly
5. Check if jumpers are correct



1. Arriva corrente alla scheda
2. Fusibile è aperto
3. Diodo è accesa
4. Controlla se i connettori motori sono connessi
5. Controlla se i ponticelli sono messi





IF MOTOR DOES NOT RUN CHECK FOLLOWING / SE IL MOTORE NON PARTE DA CONTROLLARE

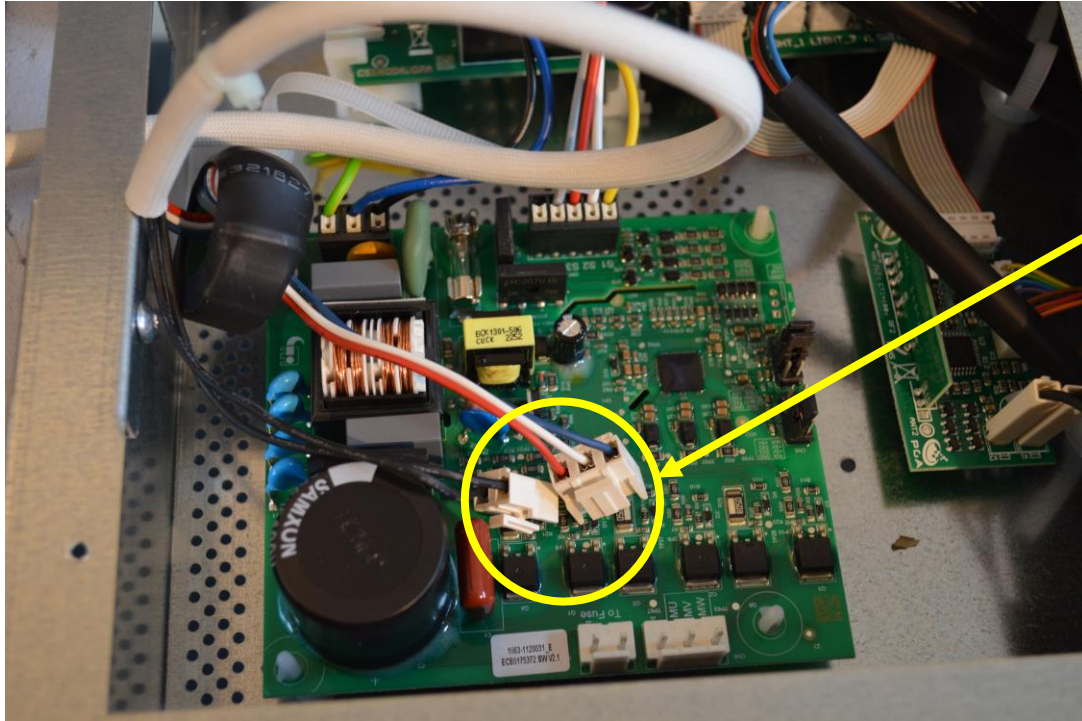

Measure the resistance between the motor wire blue-white-red it should be equal, check continuity of the black wire / misura la resistenza dei cavi motore tra blu-bianco-rosso dovrebbero essere uguale, misura la continuità del cavo nero

## HOW TO REMOVE BLOWER / COME RIMUOVERE L'ASSIEME MOTORE

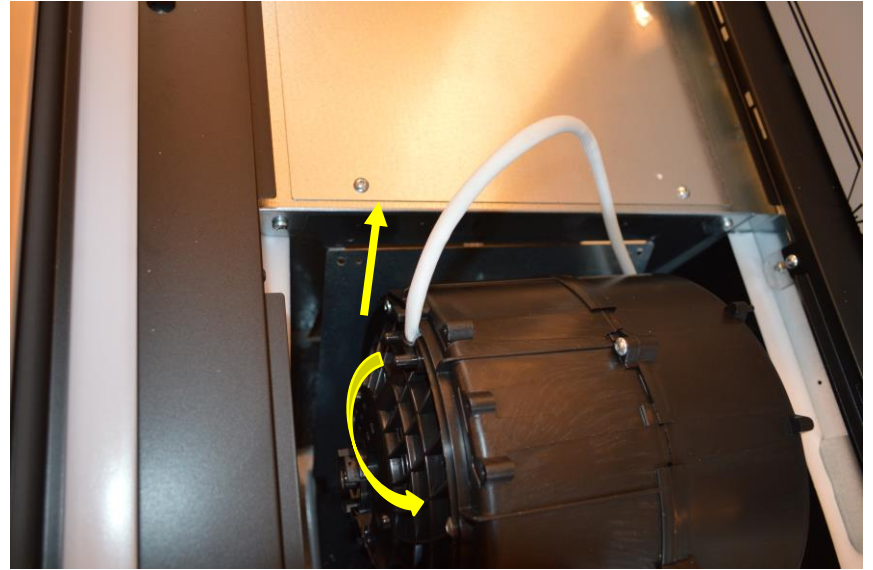
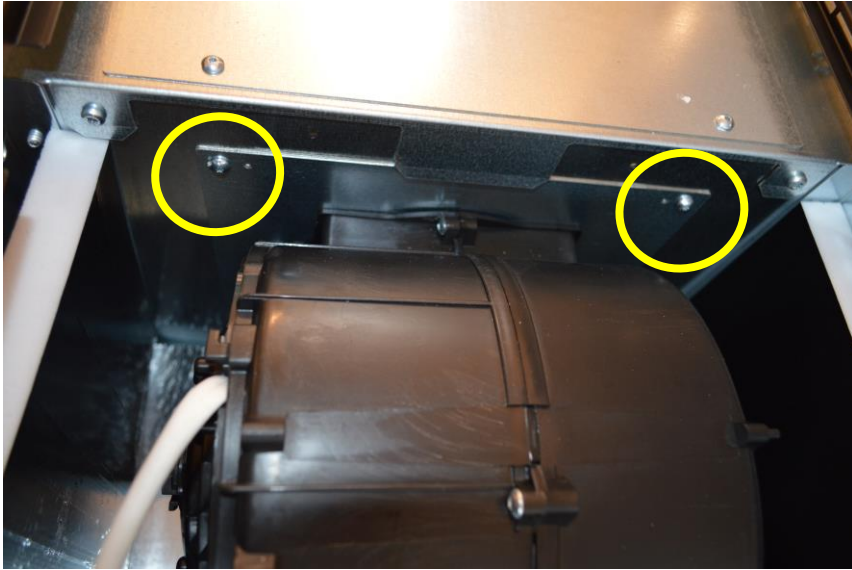

Unscrew the blower, lift-up the blower and then while rotating the blower downwards to pull it out / togliere le viti di fissaggio, sollevare il gruppo motore e ruotando verso il basso togliere il motore dalla sede.



## HOW TO REMOVE BLOWER / COME RIMUOVERE L'ASSIEME MOTORE

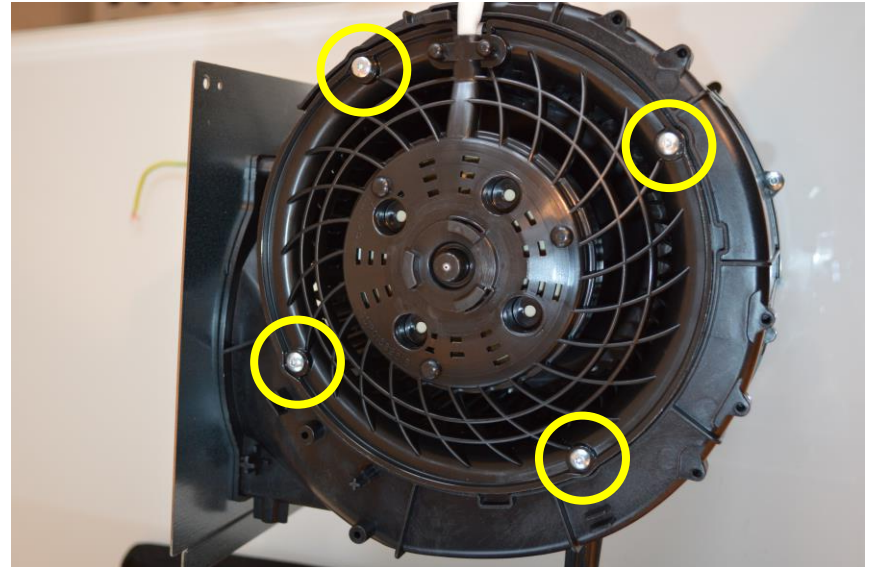
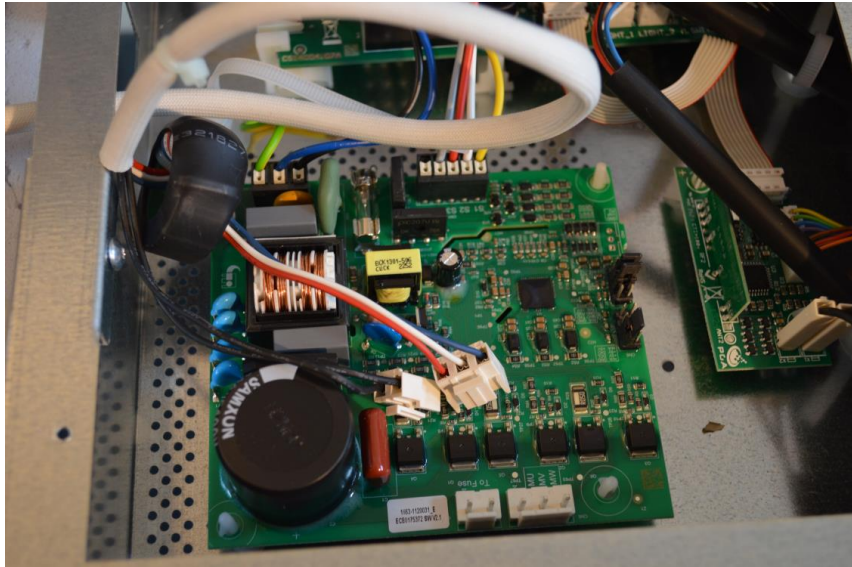

Disconnect the motor connectors and unscrew motor support / disconnettere le connessione del motore e togliere le viti fissaggio supporto motore.

## HOW TO REMOVE BLOWER / COME RIMUOVERE L'ASSIEME MOTORE

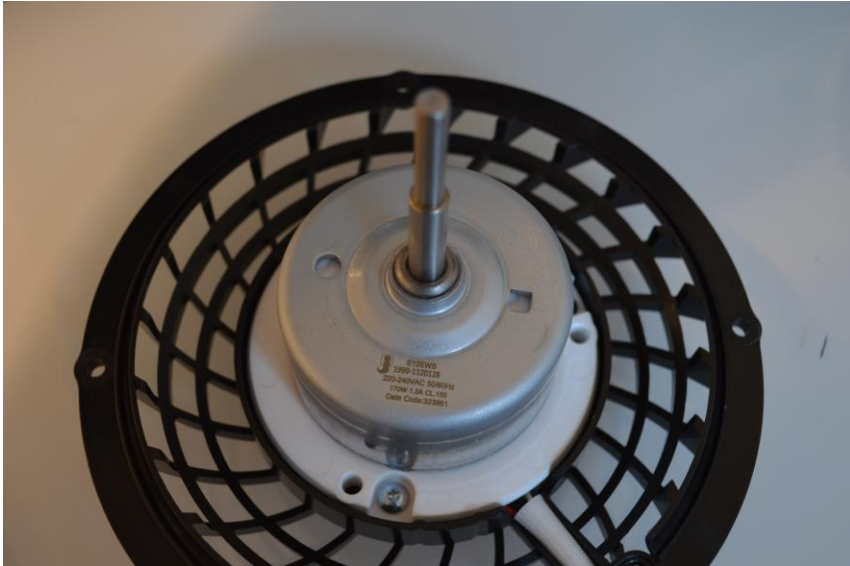

Unscrew the motor / togliere le viti fissaggio motore.

## HOW TO REMOVE LED INDICATOR / COME RIMUOVERE L'INDICATORE LED

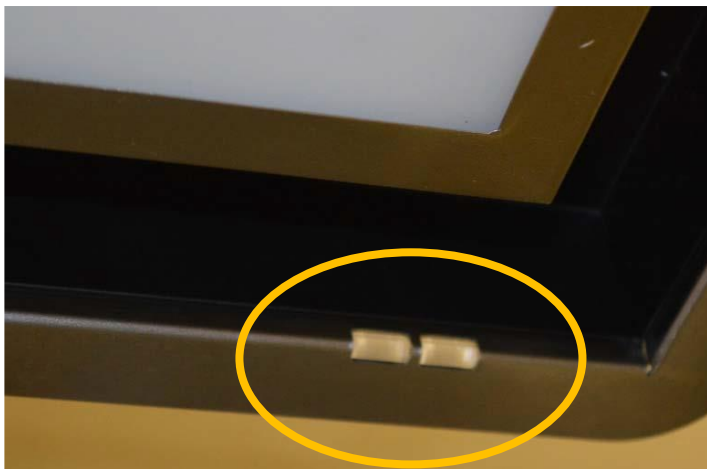

Attention: To replace the LED indicator the hood must be removed from ceiling / Attenzione: per rimuovere l'indicatore LED è necessario rimuovere la cappa dal controsoffitto

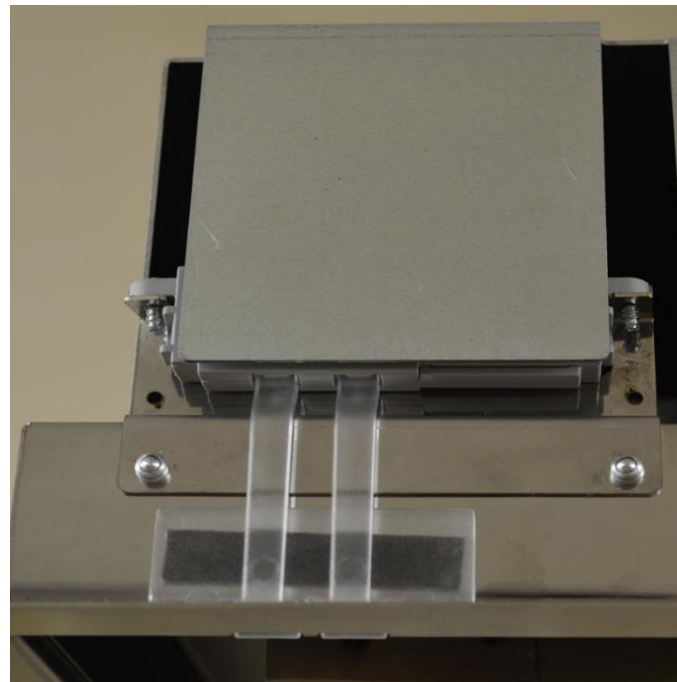

## HOW TO REMOVE LED INDICATOR UI / COME RIMUOVERE L'INDICATORE LED UI

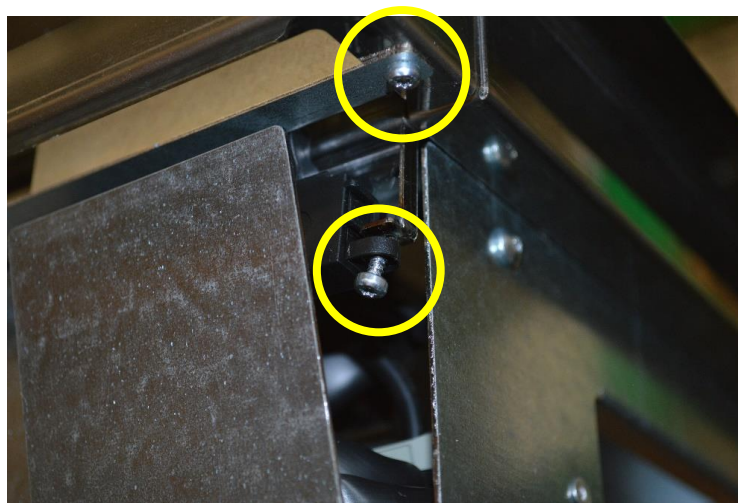
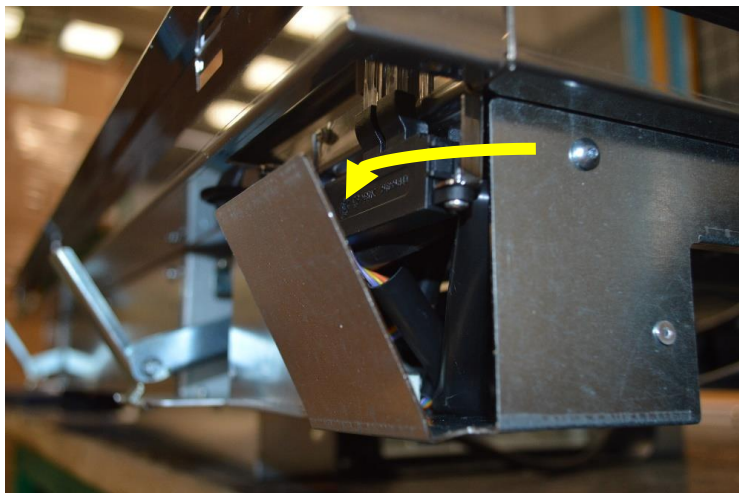

Open the metal protection by bending it slightly, after replacement reclose it. Unscrew the light protection and unscrew LED indicator. Disconnect led indicator wiring / Aprire la protezione in metallo piegandola leggermente, dopo averla chiusa richiuderla. Svitare la protezione della luce e svitare l'indicatore LED. Disconnettere il connettore dell'indicatore LED



An aerial view of a city skyline, likely New York City, with a prominent geometric overlay of semi-transparent triangles in shades of red and blue. The Empire State Building is visible in the center. The elica logo is centered in the upper half of the image.

 elica

MetLife